

ACS-5151

50 Watt PC/104 Automotive Power Supply Module
Vin = 8 ~ 40VDC

Rev. 1.0 - November 2008 - ETH_ACS-5151_USM1.0

Disclaimer

The information in this manual has been carefully checked and is believed to be accurate. Eurotech assumes no responsibility for any infringements of patents or other rights of third parties, which may result from its use.

Eurotech assumes no responsibility for any inaccuracies that may be contained in this document. Eurotech makes no commitment to update or keep current the information contained in this manual.

Eurotech reserves the right to make improvements to this document and/or product at any time and without notice.

Warranty

This product is supplied with a limited warranty. The product warranty covers failure of any Eurotech manufactured product caused by manufacturing defects. Eurotech will make all reasonable effort to repair the product or replace it with an equivalent alternative. Eurotech reserves the right to replace the returned product with an alternative variant or an equivalent fit, form and functional product. Delivery charges will apply to all returned products.

Trademarks

All trademarks, both marked and not marked, appearing in this document are the property of their respective owners.

WEEE

The information below is issued in compliance with the regulations as set out in the 2002/96/CE directive, subsequently superseded by 2003/108/CE. It refers electrical and electronic equipment and the waste management of such products.

When disposing of a device, including all of its components, subassemblies and materials that are an integral part of the product, you should consider the WEEE directive.



This symbol has been attached to the equipment or, if this has not been possible, on the packaging, instruction literature and/or the guarantee sheet. By using this symbol, it states that the device has been marketed after August 13th 2005, and implies that you must separate all of its components when possible, and dispose of them in accordance with local waste disposal legislations.

- Because of the substances present in the equipment, improper use or disposal of the refuse can cause damage to human health and to the environment.
- With reference to WEEE, it is compulsory not dispose of the equipment with normal urban refuse, arrangements should be instigated for separate collection and disposal.
- Contact your local waste collection body for more detailed recycling information.
- In case of illicit disposal, sanctions will be levied on transgressors.

RoHS

This device, including all its components, subassemblies and the consumable materials that are an integral part of the product, has been manufactured in compliance with the European directive 2002/95/EC known as the RoHS directive (Restrictions on the use of certain Hazardous Substances). This directive targets the reduction of certain hazardous substances previously used in electrical and electronic equipment (EEE).

© 2008 Eurotech Spa

Eurotech S.p.A.

A member of the Eurotech Group

Via Fratelli Solari, 3/a

33020 - AMARO (UD)

ITALY

Introduction

Conventions used within this Manual

The following conventions are used throughout this manual.

The “Mode” of the register:

Symbol / Text	Definition
RW	Readable and Writable register
RO	Read only register
W	Meaning of the register when written
R	Meaning of the register when read

Hexadecimal numbering:

Hexadecimal numbers are indicated with an “h” suffix (for example: 11Ch)

Symbols and Text used in Pin-out tables:

Symbol / Text	Definition
◀	Input
▶	Output
◀▶	Bi-Directional
—	Passive
Module specific	Dependent on module installed
NC	Not Connected
Reserved	Use reserved to Eurotech, must remain unconnected
#	Active low signal

Warnings and Important Notices:

Within this manual you will find the following tables, please ensure that you read and understand these as they are intended to highlight potential risks or precautions that should be taken.



Warnings:

Information to alert you to potential hazards:

Potential personal injury or damage to a system, device, or program.



Information and/or Notes:

Indicates important features or instructions that should be observed

Technical Assistance

If you have any technical questions or if you cannot isolate a problem with your device, please e-mail the Eurotech Technical Support Team: email: techsupp@eurotech.com

Before returning any Eurotech product, for any reason, you must e-mail the Eurotech Technical Support Team on the above email address, giving the following information; you will then be sent an RMA number (Returned Material Authorization) for the return of the material:

- Model number (see Figure 1)
- Serial number (see Figure 1)
- Detailed fault description
- Company Details
- Contact details

Transportation

When transporting the module for any reason it should be packed using anti-static material and placed in a sturdy box with enough packing material to adequately cushion it.

**Warning:**

Any product returned to Eurotech that is damaged due to inappropriate packaging will not be covered by the warranty!

Board labelling

On the external side of the ISA Bus connector, you will find several labels displaying the following:

- Batch Number
- Serial Number
- Model Number
- Hardware Revision

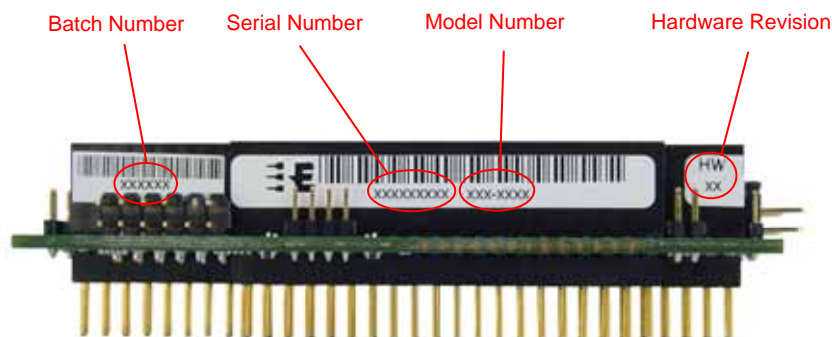

Figure 1. Board label locations

Table of Contents

Introduction	3
Conventions used within this Manual	3
<i>The “Mode” of the register:</i>	3
<i>Hexadecimal numbering:</i>	3
<i>Symbols and Text used in Pin-out tables:</i>	3
<i>Warnings and Important Notices:</i>	3
Technical Assistance	4
Transportation.....	4
Board labelling	4
Table of Contents	5
Chapter 1 Product Overview	7
Product Definition	8
<i>General Features:</i>	8
Block Diagram	9
Electrical and Environmental Specifications.....	10
<i>Operating Characteristics</i>	10
<i>Absolute Maximum Ratings</i>	10
<i>MTBF</i>	10
Chapter 2 Jumper Description	11
Jumper Layout	11
Chapter 3 Connector Description	13
Connector Layout	13
How to connect the ACS-5151 to other PC/104 & PC/104-Plus devices.....	14
<i>The ISA Bus: J1 and J2</i>	14
<i>The stack assembly</i>	16
Power input connector: +8 to +40V	17
Output connector: +12V.....	17
+3.3V Output connector.....	18
+5V Output connector.....	19
External power connector.....	19
Chapter 4 Power Supply Description	21
Input protection and filtering	21
<i>Reverse voltage protection</i>	21
<i>Over voltage protection</i>	21
<i>Input filtering</i>	21
+5V DC/DC step down converter module	22
<i>Current Limit</i>	22
<i>Remote On/Off control</i>	22
+12V step up converter	22
Status LED indicators	23

Appendix25
A.1. Mechanical Dimensions25
A.2. Manual Revision History26
Eurotech Group Worldwide presence27

Chapter 1 Product Overview

In the following paragraphs, you will find a brief description of the ACS-5151 characteristics.

The ACS-5151 vehicle power supply is designed to meet the system design requirements of vehicle, machine, industrial, and mobile installations. It offers resistance to high levels of shock and vibration and has a rugged mechanical design. All heavy components are glued to the board.

Reverse protection up to -45VDC and short-term tolerance of spikes up to 50V (1ms) make this power supply the ideal choice for battery operated +12V or +24V systems. Dedicated high power automotive voltage suppression circuitry will dissipate up to 6KW of transient energy (10/1000us waveform) meeting the ISO7637-2 surge specification. The onboard input filter and protection circuitry is designed to meet the requirements of the EC low voltage directives for CE compliance EN55022-B and EN61000 and MIL-STD-461 for radiated and conducted emissions. Emissions are reduced by optimal layout, as well as EMI filtering of all the board outputs including the power applied into the PC/104 computer bus.

The output voltages are supplied to the PC/104 bus as well as terminal blocks mounted on the board. The +3.3V output can be used to power other low voltage peripherals in the system such as LCD panels, GPS receivers or wireless communication devices. LED indicators display the status of the +5V and +12V power outputs.

For a complete list of our products visit our website: www.eurotech.com

Product Definition

General Features:

Architecture

- PC/104 compliant

Voltage Input:

- VIN=+8 VDC to +40 VDC
- High transient voltage margin (50V 1ms)

Voltage Output:

- +5V, +12V, +3.3VDC

Power Output:

- Up to 50 Watts Combined (+5V@10A, +3.3V@2A, +12V@2A)

Input Protection:

- Reverse over-voltage and load-dump protection
- Input protected with automotive transient voltage suppressor (6600W 10/1000us)
- Suitable for 12 or 24 V battery installations

EMI Input Filter:

- Onboard input filter designed to comply with MIL-STD-461, CE, and EN-55022 class B conducted and radiated emissions

Power Connectors:

- PC/104 Bus
- Screw Clamp Terminal Blocks;
- HDD Terminal Block

RoHS:

- Fully RoHS (2002/95/CE) Compliant
- RoHS replacement for ACS-5150

Block Diagram

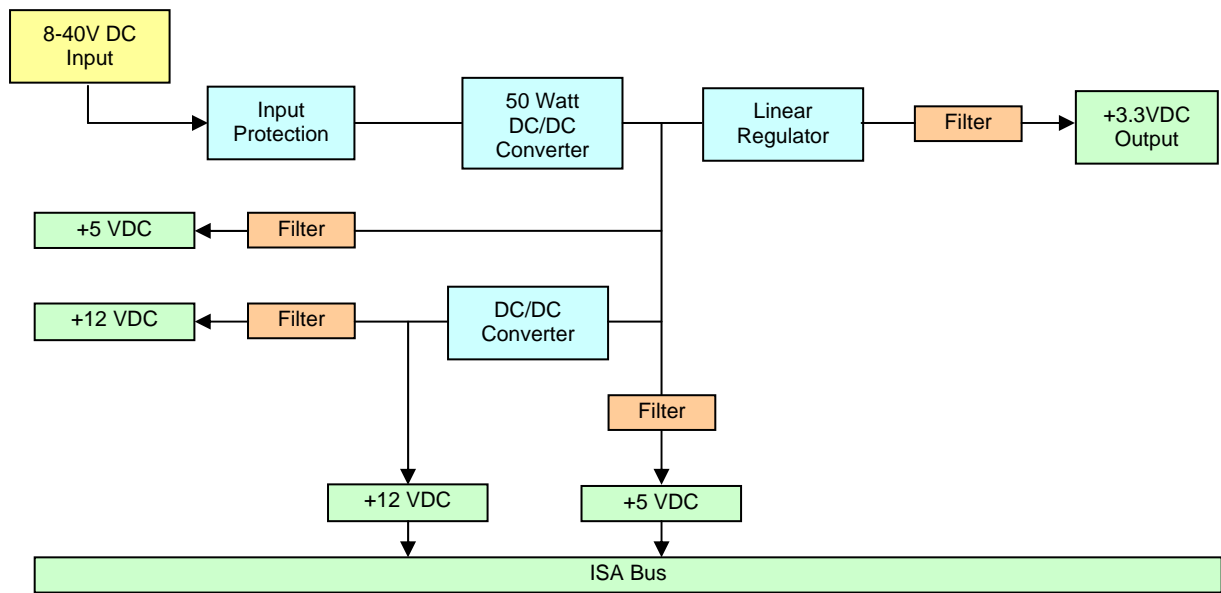

Figure 2. Functional block diagram of the ACS-5151 vehicle class power supply

Electrical and Environmental Specifications

Operating Characteristics

Electrical Operating Characteristics

Parameter	Nominal [VDC]	Specification [+/- %]	Minimum [VDC]	Maximum [VDC]
Voltage Output	+3.3	1.5	3.25	3.35
	+5.0	5	4.75	5.25
	+12.0	-4.2 /+1.6	11.5	12.2
Voltage Input	+12.0 or +24.0		+8.0	+40.0*
Power output	Up to 50 Watts Combined (+5V@10A, +3.3V@2A, +12V@2A)			

*High transient voltage margin (50V 1ms)

Operating Temperature Range

For correct operation of the module, the ambient air temperature must remain within the following range:

Range	Minimum	Maximum
Standard	-40 °C	+85 °C

Absolute Maximum Ratings

Description	Minimum	Maximum
Supply Voltage	7.5 V	40.0 V
Storage Temperature Range	-45 °C	+85 °C
Non-Condensing Relative Humidity		<95% at 40°C

Warning:



Stressing the module beyond the “Absolute Maximum Ratings” may cause permanent damage. These are stress ratings only. Operation beyond the “Operating Conditions” is not recommended. Extended exposure beyond the “Operating Conditions” may affect device reliability

MTBF

Hours	997,079 Hours (Ground Benign, Controlled GB, GC) 157,971 Hours (Airborne Inhabit Fighter, AIF)
Standard	MIL-HDBK-217F @ 40°C

Chapter 2 Jumper Description

Jumper Layout

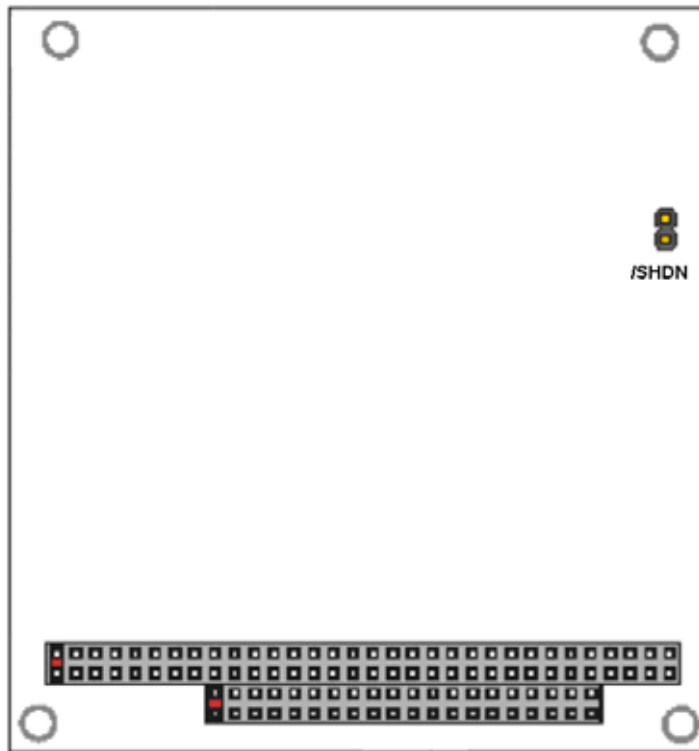

Figure 3. Jumpers and solder jumpers

Label	Function	Type	Options	Factory Default
/SHDN	Shutdown Control	2pin jumper	Closed: Turns off the complete power supply Open: Power supply module fully operational	Open

Table 1. Jumper Functions

(This page is intentionally left blank.)

Chapter 3 Connector Description

Connector Layout

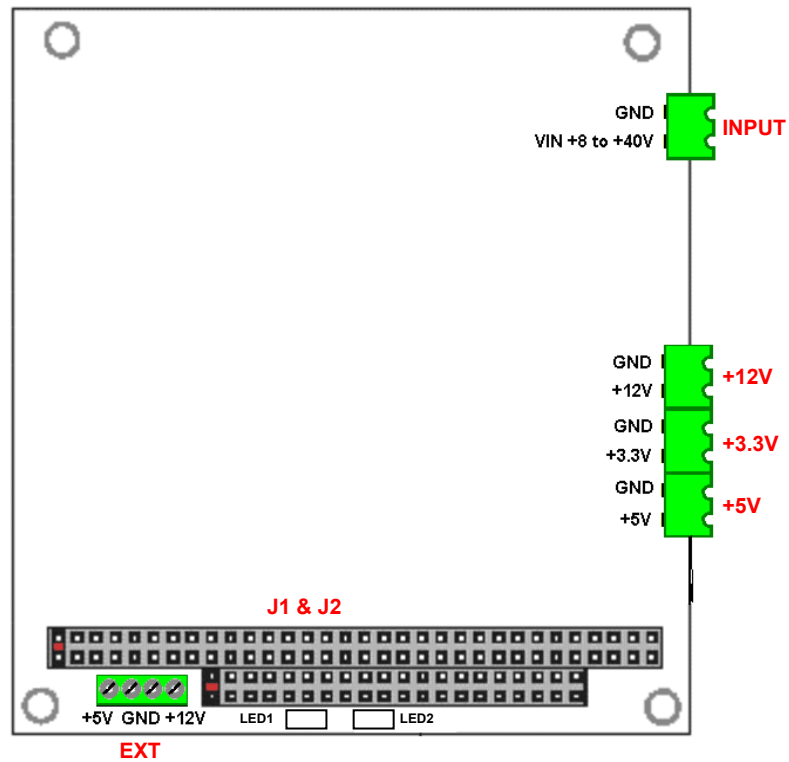

Figure 4. Connector layout

Connector	Function
J1 & J2	ISA BUS (PC/XT)
INPUT	+ 8 to +40V DC input
+3.3V	+3.3V screw terminal plug
+5V	+5V screw terminal plug
+12V	+12V screw terminal plug
EXT	+5V and +12V output

Table 2. Connector functions

How to connect the ACS-5151 to other PC/104 & PC/104-Plus devices

The ISA Bus: J1 and J2

Connectors J1 and J2 carry the signals for the ISA Bus.

These signals match the definitions of the IEEE P996 standard.

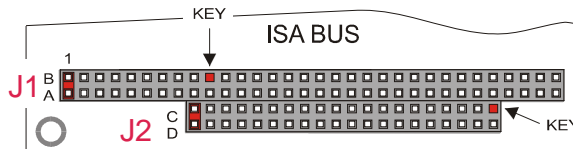

Figure 5. ISA BUS layout

According to the PC/104 specifications, these connectors include KEY pins; these are filled holes in the upper side and missing pins in the lower side of the bus. This is done to avoid the wrong insertion in/of another module.

Pin #	Use	Signal	Pin #	Use	Signal
1	ISA Bus	IOCHK#	33	ISA Bus	A14
2	ISA Bus	Ground	34	ISA Bus	DACK1#
3	ISA Bus	D7	35	ISA Bus	A13
4	ISA Bus	RSTDRV	36	ISA Bus	DRQ1
5	ISA Bus	D6	37	ISA Bus	A12
6	ISA Bus	+5 Volts	38	ISA Bus	REFRESH#
7	ISA Bus	D5	39	ISA Bus	A11
8	ISA Bus	IRQ 9	40	ISA Bus	ISACKL
9	ISA Bus	D4	41	ISA Bus	A10
10	ISA Bus	-5 Volts	42	ISA Bus	IRQ 7
11	ISA Bus	D3	43	ISA Bus	A9
12	ISA Bus	DRQ2	44	ISA Bus	IRQ 6
13	ISA Bus	D2	45	ISA Bus	A8
14	ISA Bus	-12 Volts	46	ISA Bus	IRQ 5
15	ISA Bus	D1	47	ISA Bus	A7
16	ISA Bus	ZEROWS#	48	ISA Bus	IRQ 4
17	ISA Bus	D0	49	ISA Bus	A6
18	ISA Bus	+12 Volts	50	ISA Bus	IRQ 3
19	ISA Bus	IOCHRDY	51	ISA Bus	A5
20	Not Connected	Key	52	ISA Bus	DACK2#
21	ISA Bus	AEN	53	ISA Bus	A4
22	ISA Bus	SMEMW#	54	ISA Bus	TC
23	ISA Bus	A19	55	ISA Bus	A3
24	ISA Bus	SMEMR#	56	ISA Bus	BALE

Pin #	Use	Signal	Pin #	Use	Signal
25	ISA Bus	A18	57	ISA Bus	A2
26	ISA Bus	IOW#	58	ISA Bus	+5 Volts –1
27	ISA Bus	A17	59	ISA Bus	A1
28	ISA Bus	IOR#	60	ISA Bus	OSC
29	ISA Bus	A16	61	ISA Bus	A0
30	ISA Bus	DACK3#	62	ISA Bus	Ground 1
31	ISA Bus	A15	63	ISA Bus	Ground 3
32	ISA Bus	DRQ3	64	ISA Bus	Ground 2

Table 3. J1 pinout

Pin #	Use	Signal	Pin #	Use	Signal
1	ISA Bus	Ground 0	21	ISA Bus	MEMW#
2	ISA Bus	Ground 1	22	ISA Bus	DACK5#
3	ISA Bus	SBHE#	23	ISA Bus	SD8
4	ISA Bus	ISA_MEMCS16#	24	ISA Bus	DRQ5
5	ISA Bus	LA23	25	ISA Bus	SD9
6	ISA Bus	IOC16#	26	ISA Bus	DACK6#
7	ISA Bus	LA22	27	ISA Bus	SD10
8	ISA Bus	IRQ10	28	ISA Bus	DRQ6
9	ISA Bus	LA21	29	ISA Bus	SD11
10	ISA Bus	IRQ11	30	ISA Bus	DACK7#
11	ISA Bus	LA20	31	ISA Bus	SD12
12	ISA Bus	IRQ12	32	ISA Bus	DRQ7
13	ISA Bus	LS19	33	ISA Bus	SD13
14	ISA Bus	IRQ15	34	ISA Bus	+5 Volts
15	ISA Bus	LA18	35	ISA Bus	SD14
16	ISA Bus	IRQ14	36	ISA Bus	MASTER#
17	ISA Bus	LA17	37	ISA Bus	SD15
18	ISA Bus	DACK0#	38	ISA Bus	Ground 2
19	ISA Bus	MEMR#	39	ISA Bus	Not Connected
20	ISA Bus	DRQ0	40	ISA Bus	Ground 3

Table 4. J2 pinout

**Note:**

For further information regarding the ISA and PCI bus, please visit the Eurotech website (<http://www.eurotech.com/>), referring to the section titled “Industry Standards.”

The stack assembly

The ISA and PCI bus connectors of the module are designed to allow it to be connected with other PC/104 and/or PC/104-Plus devices, we recommend users to follow this procedure to ensure that stacked modules are not damaged.



Warning:

Appropriate ESD (Electro Static Discharge) precautions should be used for the following procedure.

1. Turn off the power to the PC/104 (or PC/104-Plus) system or stack.
2. Select and install standoffs as required to correctly position the module on the PC/104 stack.
3. Remove the module from its anti-static bag.
4. Check that keying pins in the bus connector are correctly positioned.
5. Check the stacking order; make sure an XT bus card will not be placed between two AT bus cards or it will interrupt the AT bus signals.
6. Hold the module by its edges and orient it so that the bus connector pins line up with the matching connector on the stack.
7. Press the module evenly onto the PC/104 stack.

Figure 6 shows a typical module stack with two PC/104 modules, one PC/104 16-BIT module, and one PC/104 8-BIT module.

The maximum number of modules is four in addition to the Host Board.

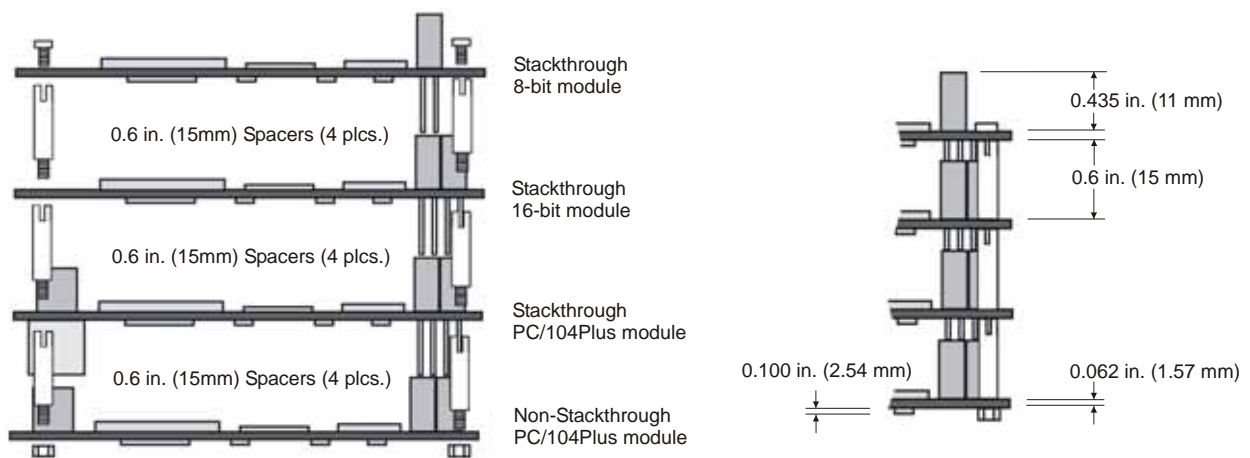

Figure 6. The Module Stack



Warning:

Do not force the module onto the stack! Wiggling the module or applying too much pressure may damage it. If the module does not readily press into place, remove it, check for bent pins or out-of-place keying pins, and try again.

Power input connector: +8 to +40V

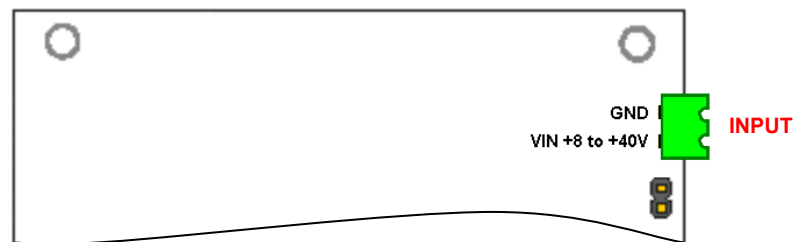

Figure 7. Input power connector

Use:

Connecting raw input power to the ACS-5151 power supply and system.

Description:

The ACS-5151 accepts a wide input voltage range from +8V to +40V DC. This makes it the ideal power supply for automotive installations requiring compliance with EN50155. The input is reverse voltage protected up to 45V. Transient protection diodes as well as a varistor are used to protect the input of the power supply. Low radiated and conducted emissions are achieved by a purpose built input filter. The input will withstand over voltages up to 50V for 1ms. As the input power of the module can reach 65 Watts, it is important to ensure that suitable input cables are used.

Output connector: +12V

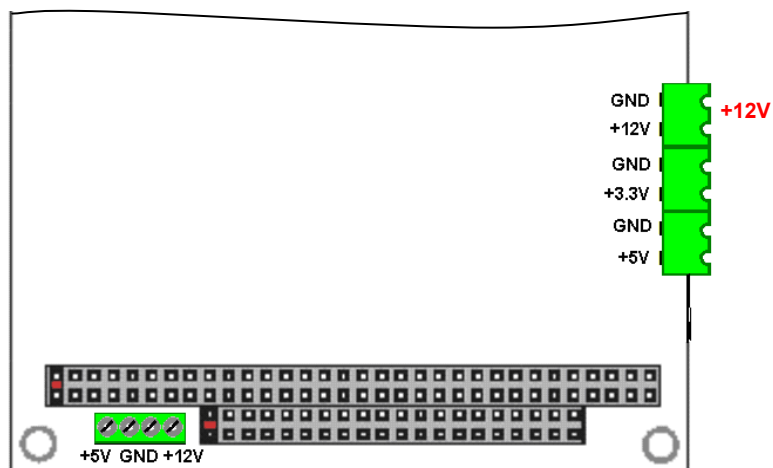

Figure 8. +12V output connector

Use:

+12 Volt Output

Description:

A +12 Volts / 24 Watt output switching DC/DC converter is used to create +12 Volts from +5 Volts. This converter feeds power into the PC/104 bus pins and is available for peripheral device connection on the locking screw terminal block as shown Figure 8. The +12 Volts is filtered to reduce radiated noise on the output. The maximum output current of the +12 Volts output is 2.5 Amperes. The output is over-current protected and will withstand a permanent short circuit condition.

+3.3V Output connector

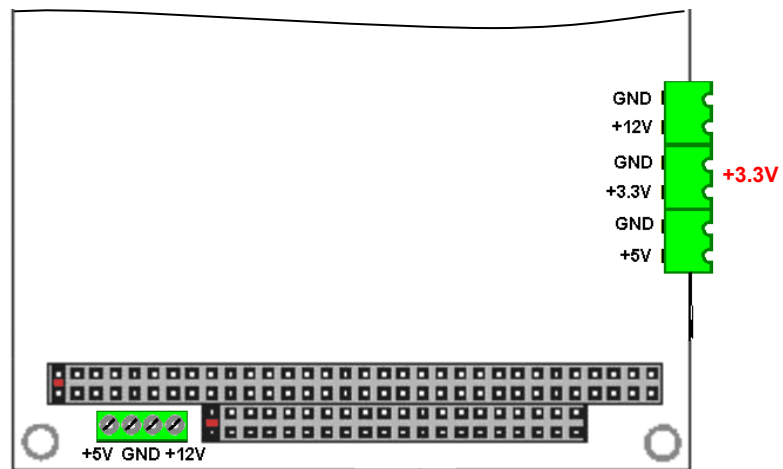

Figure 9. +3.3V output connector

Use:

+3.3Volt Output

Description:

A +3.3V linear regulator is cascaded on the +5V regulator output. This output is only available on this connector. +3.3V is not supplied to the PC/104 bus. The maximum output available current is 2A. This output can be used for various low power peripheral devices in a system such as GPS receivers, TFT displays etc.

+5V Output connector

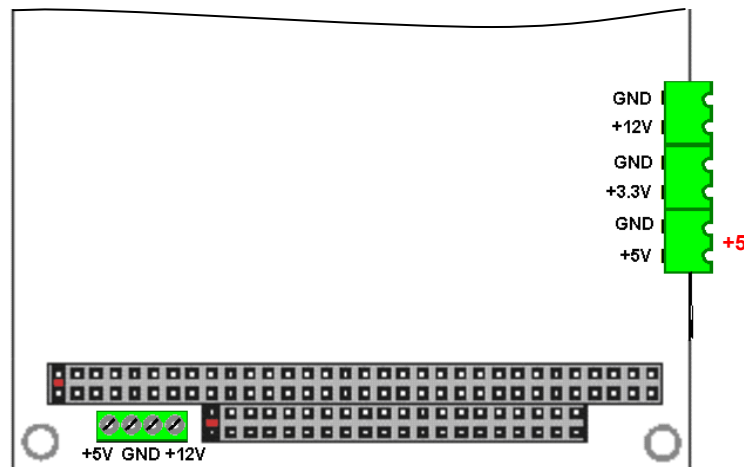

Figure 10. +5V output connector

Use:

+5.0Volt Output

Description:

A 5 Volt / 50 Watt switching DC/DC converter is used to power your complete 5 Volt system. This converter feeds power into the PC/104 bus pins and is available for peripheral device connection on the locking screw terminal block as shown in Figure 10. The +5 Volt output is filtered to reduce radiated noise. The maximum output current of the +5 Volt converter is 10 Amperes. The power consumption of the additional +3.3 Volt and +12 Volt converters must be taken into consideration while performing power calculations, as these cascaded converters draw power from the main +5 Volt output.

External power connector

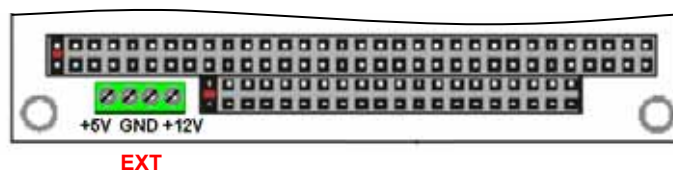

Figure 11. External power connector

Use:

+5V and +12V power outputs

Description:

The external power output connector has two ground pins in the middle and additionally +5V and +12V. Use this screw terminal block to connect to your standard peripheral devices such as HD and CD-ROM drives.



Warning:

Power terminals are connected in parallel with the equivalent outputs described above.

(This page is intentionally left blank.)

Chapter 4 Power Supply Description

Input protection and filtering

Reverse voltage protection

Input power reversal is a common error condition in power supply connection or installation in hostile electrical environments. The ACS-5151 power supply will withstand reverse voltages up to 45V indefinitely. A series Schottky diodes on the positive supply input line also protects the transient absorber diodes from forward conducting in a reverse voltage condition. The reverse voltage protection diode is rated for a 9.0A input current.

Over voltage protection

A high-speed automotive transient absorber diode (6600W 10/1000us) will clip all input transients below acceptable limits. The input filters will also reduce the incoming energy of the over voltage pulse. The ACS-5151 will tolerate a short-term over voltage condition up to 50V for a period of 100ms and a long-term supply voltage up to 40VDC. A 5A rated thermal fuse mounted on the solder side of the board is connected in series with the input. The normal maximum input current to the power supply is 8.1A assuming the input power is 65W.

Input filtering

Low radiated and conducted emissions are important when selecting power supplies for professional embedded systems. All the power outputs from the onboard DC/DC converter subsystems are filtered using power ferrites reducing emissions in the frequency range of 30 to 150MHz. The ACS-5151 will exceed the requirements of the EC low voltage directives for CE compliance. An input filter specially dimensioned for the ACS-5151 power supply ensures compatibility with EN-55022 class B or MIL-STD-461 requirements for conducted and radiated emissions.

The frame of the module (as well as the chassis if it is conductive) may be connected to the ground of the power supply input. Close B1 with a solder blob to make this connection next to the input connector of the power supply.

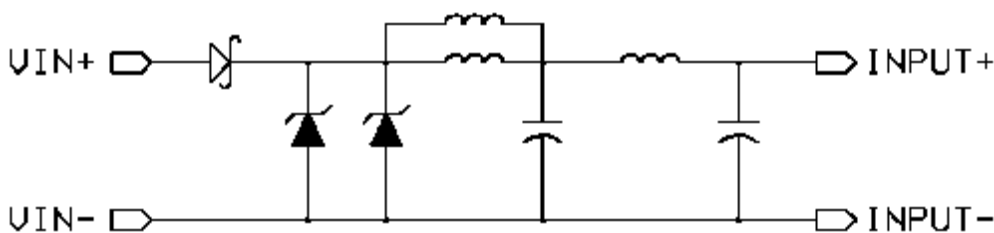

Figure 12. Input filter of the ACS-5151

+5V DC/DC step down converter module

The main +5V output is designed and based on an extended temperature range 5W switching step-down DC-DC converter. The converter output current is internally limited to 10A. The filtering and shielding of the DC/DC converter ensures low input ripple current and low radiated noise under all load conditions. Use of optimal PCB layout and use of low ESR OSCON capacitors ensures un-degraded performance over the complete operating temperature range of -40 to +85°C.

The input of this converter is protected to meet the requirements of automotive, industrial and vessel installations. Fast transient absorber diodes and a low loss 9A forward biased Schottky diode are necessary to protect the input in 12V or 24V automotive and industrial installations against fast over voltage spikes and reverse voltage transients. The module will tolerate voltage spikes up to 50V for 100ms.

The main +5V converter supplies the PC/104 +5V bus with power. This power is available for external devices from an external terminal block. (Refer to the LED Description for location information.)

Current Limit

To protect the ACS-5151 against fault or error conditions the +5V DC/DC converter circuit is equipped with a current limiter to provide continuous overload protection. After reaching the current limit point (typically 5 - 10% exceeding the rated maximum current), the output voltage will vary between the rated nominal output and zero depending on the level of overload. Once the short circuit condition is removed, the output will return to the nominal value without restarting the power supply or switching power off.

Remote On/Off control

The header connector labelled SD near the input terminal block of the board is the remote ON/OFF control. Closing this contact will disengage the ACS-5151 and place the converter in standby condition. In this condition, the ACS-5151 will still consume some power. This control signal could be connected to the ignition key of an automobile, vehicle or machine.

+12V step up converter

A highly efficient step-up DC/DC converter generates the +12V volts for peripheral devices such as EL- or TFT- panels, hard drives, motors etc. The +12V output can supply up to 2.0A continuously within the specified temperature range (-40 to +85°C). The high-level output current will ensure that the converter can respond to short-term currents. The +12V supply is available from terminal block and the 4-position screw terminal block near the bus connector. The +12V supply also powers the PC/104 bus power pins. The +12V power outputs are filtered with ferrites to reduce the radiated emissions from the board.

Status LED indicators

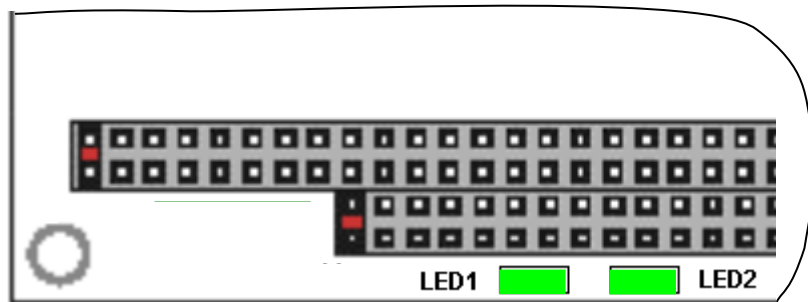

Figure 13. Status LED locations

Use:

Board Status

Description:

There are two green status LED's located next to the PC/104 bus connector these are used to indicate the status and state of the ACS-5151.

LED Name	Status	Description
LED1	ON	+5V OK
LED2	ON	+12V OK

Table 5. LED status

(This page is intentionally left blank.)

Appendix

A.1. Mechanical Dimensions

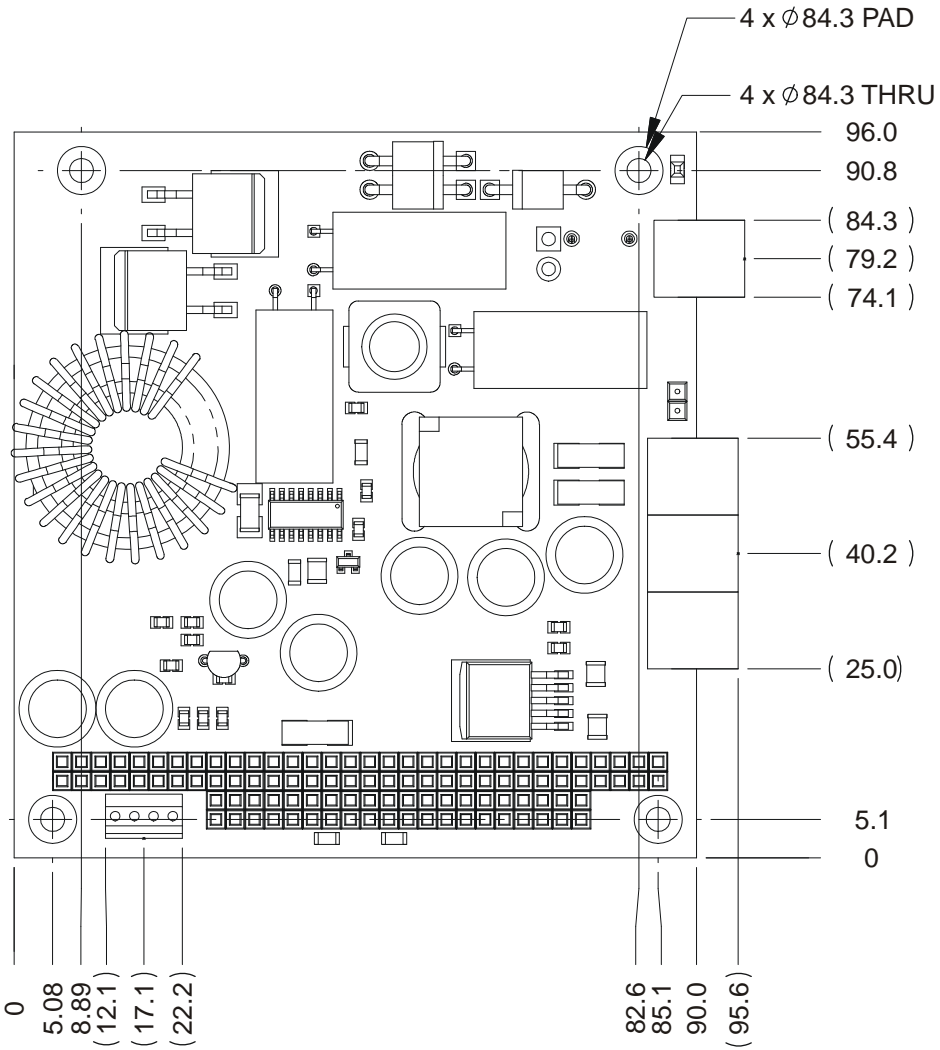

Dimensions are in millimetres

Figure 14. ACS-5151 Board dimensions



Note:

For further information about the mechanical dimensions of ISA and PCI buses please refer to the PC/104 consortium site (www.pc104.org)

A.2. Manual Revision History

REVISION	DESCRIPTION	DATE
1.0	First Release	November 2008

Eurotech Group Worldwide presence

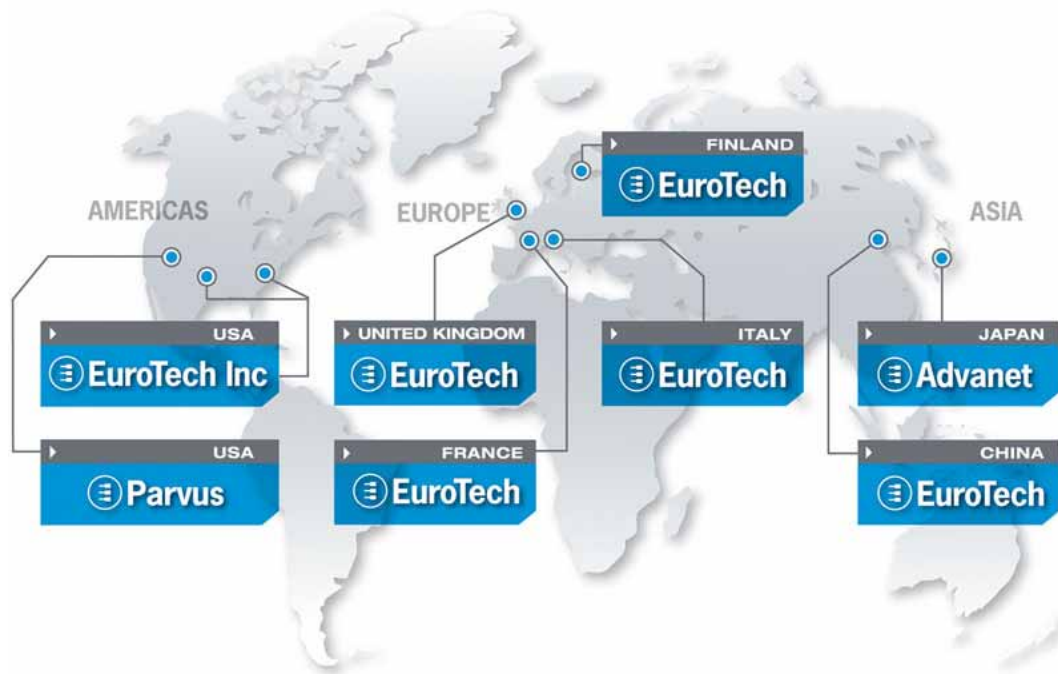

AMERICAS

EUROPE

ASIA



North America

EUROTECH Inc
 toll free +1 888.941.2224
 tel. +1 301.490.4007
 fax +1 301.490.4582
 e-mail: sales-us@eurotech.com
 e-mail: support-us@eurotech.com
 www.eurotech-inc.com

PARVUS CORPORATION
 tel. +1 800.483.3152
 fax +1 801.483.1523
 e-mail: sales@parvus.com
 e-mail: tsupport@parvus.com
 www.parvus.com

Central & Southern Europe

EUROTECH Italy
 tel. +39 0433.485.411
 fax +39 0433.485.499
 e-mail: sales-it@eurotech.com
 e-mail: support-it@eurotech.com
 www.eurotech.com

Western Europe

EUROTECH UK
 tel. +44 (0) 1223.403410
 fax +44 (0) 1223.410457
 e-mail: sales-uk@eurotech.com
 e-mail: support-uk@eurotech.com
 www.eurotech.com

EUROTECH France
 tel. +33 04.72.89.00.90
 fax +33 04.78.70.08.24
 e-mail: sales-fr@eurotech.com
 e-mail: support-fr@eurotech.com
 www.eurotech.com

Northern & Eastern Europe

EUROTECH Finland
 tel. +358 9.477.888.0
 fax +358 9.477.888.99
 e-mail: sales-fi@eurotech.com
 e-mail: support-fi@eurotech.com
 www.eurotech.com

ADVANET Japan
 tel. +81 86.245.2861
 fax +81 86.245.2860
 e-mail: sales@advanet.co.jp
 www.advanet.co.jp

EUROTECH China
 tel. +86 10.62.67.09.04
 fax +86 10.62.67.09.54
 e-mail: sales-cn@eurotech.com
 e-mail: support-cn@eurotech.com
 www.eurotech.com



